









# 280 TJ

TECHNICAL DATA SHEET



[www.manitou.com](http://www.manitou.com)

# 280 TJ

		280 TJ
	<b>Working height</b>	27.75 m
	<b>Platform height</b>	25.75 m
	<b>Outreach</b>	21.45 m
	<b>Jib tilting</b>	+70°/-70°
	<b>Basket rotation</b>	+90°/-90°
	<b>Turret rotation</b>	continuous
	<b>Capacity</b>	350 kg (3 pers.) 240 kg (2 pers.)
	<b>Basket (width and length)</b>	2.30 x 0.90 m
	<b>1. Overall width</b>	2.43 m
	<b>2. Overall length</b>	11.35 m
	<b>3. Overall height</b>	2.75 m
	<b>4. Overall length when folded</b>	8.04 m
	<b>5. Overall height when folded</b>	2.72 m
	<b>6. Inside turning circle</b>	2.00 m
	<b>7. Outside turning circle</b>	4.33 m
	<b>8. Turning Radius (basket)</b>	9.75 m
	<b>9. Ground clearance</b>	43 cm
	<b>10. Wheelbase</b>	2.80 m
	<b>Speed of forward movement</b>	4.70 kph
	<b>Working speed</b>	0.80 kph
	<b>Maximum slope accessible</b>	40 %
	<b>Maximum tilt</b>	4°
	<b>Tyres</b>	385/45-28
	<b>Driving wheels</b>	4
	<b>Steering/directional wheels</b>	4
	<b>Weight</b>	16 500 kg
	(varies according to options & standards of the country)	
	<b>Engine</b>	KUBOTA V2403-M
	<b>Power</b>	45 HP
	<b>Environmental noise (LWA)</b>	105 dB

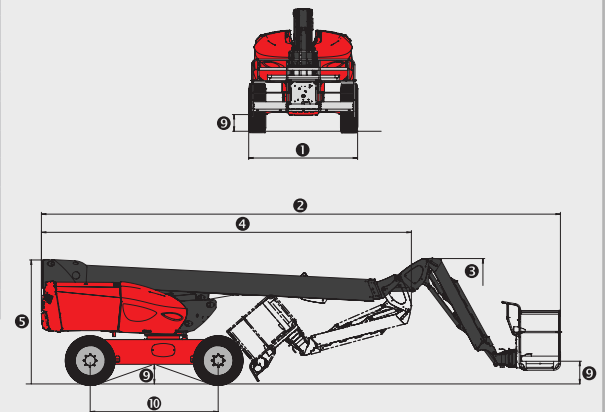
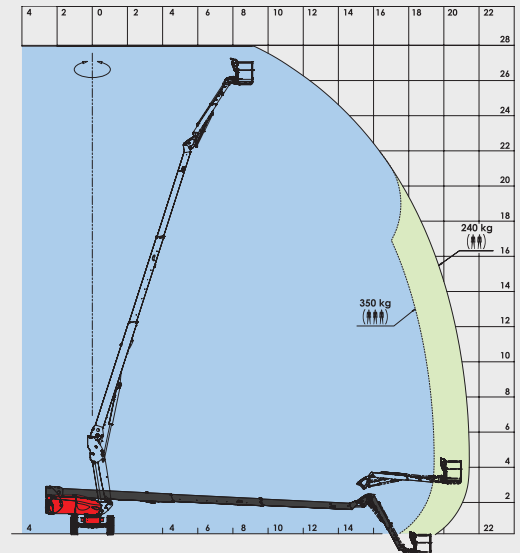

## Standard equipment

Telescopic Jib
Oscillating front axle
Continuous Rotation
Large Basket
Proportional levers
4 simultaneous movements
4 wheel drive
4 wheel steer
Wheels crab position
Mouvements X/Y (horizontaux, verticaux)
Foam filled tyres
Differential Lock
Front Axle limited slip differential
On Board Diagnostics
Hour meter
Fuel gauge with low level warning
Tool box
Protective cover with optional locking
Horn
Beacon
Audible and visual display alarm for excessive slope
Code Protected Machine Set Up
Hooks for sling loading/lifting
Electric Pump
Predisposition 230V
Dead man pedal

## Optional equipment

Onboard generator (5 kVA)
230V power input with differential circuit-breaker
Predisposition compressed air
Predisposition of water
Working light
Special paint
Biodegradable oil
Warning Alarm for all movements
Warning Travel Alarm
Catalytic Converter
Spark Arrester and overrun valve
Anti Theft code
Certificate of verification
Safety harness

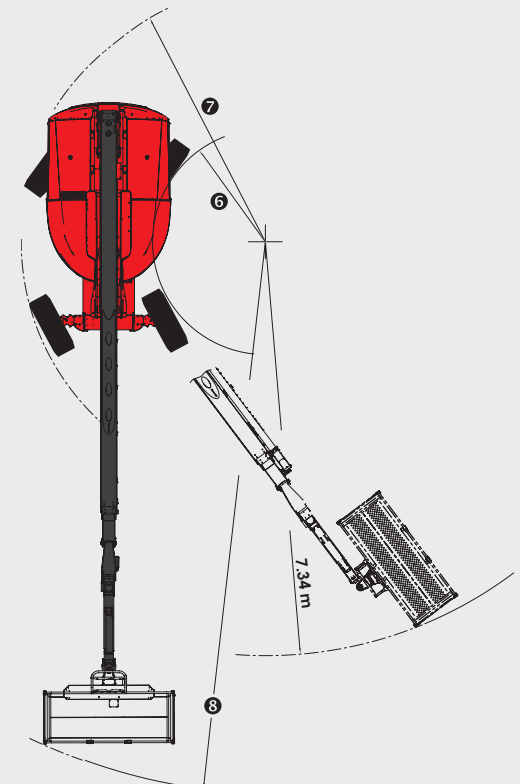

This brochure describes versions and configuration options for MANITOU products which may be fitted with different equipment. The equipment described in this brochure may be standard, optional or not available depending on version. MANITOU reserves the right to change the specifications shown and described at any time and without prior warning. The manufacturer is not liable for the specifications given. For more information, contact your MANITOU dealer. Non-contractual document. Product descriptions may differ from actual products. List of specifications is not comprehensive. The logos and visual identity of the company are the property of MANITOU and may not be used without authorisation. All rights reserved. The photos and diagrams contained in this brochure are provided for information only.

MANITOU BF SA - Limited company with board of directors - Share capital: 39,547,824 euros - 857 802 508 RCS Nantes

